



Investing & Partnering Forum on Biomedicine & ICTs
Polaris Science & Technology Park
Pula, Sardinia (Italy) - 22/23 October 2009

www.investinpolaris.it

CRS4

« a special place » built on
Information Science & Technology
and Bioinformatics

Paolo Zanella



Investing & Partnering Forum on Biomedicine & ICTs
Polaris Science & Technology Park
Pula, Sardinia (Italy) - 22/23 October 2009

www.investinpolaris.it

Origins: CERN, Geneva

HPC & Networks, Birthplace of the WWW, ICT and Data Handling for Particle Physics Research, Modelling & Simulations for accelerators and complex experiments

EBI, Cambridge - W.T. Genome Campus

Bioinformatics R&D, Genome Sequence collection and analysis, Protein Data Bank, Gene Expression Data Analysis, Database Services for biological data, Elixir

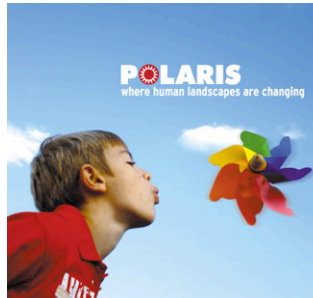

Investing & Partnering Forum on Biomedicine & ICTs
Polaris Science & Technology Park
Pula, Sardinia (Italy) - 22/23 October 2009

www.investinpolaris.it

CENTER OF EXCELLENCE

State-of-the-art R&D
in ICT, HPC, and Bioinformatics
applied to strategic fields as:
Biomedicine & Healthcare
Energy & Environment

AGENT OF TECHNOLOGICAL INNOVATION

promoting new ventures
providing high-tech support to companies in the
Polaris Science & Technology Park



Investing & Partnering Forum on Biomedicine & ICTs
Polaris Science & Technology Park
Pula, Sardinia (Italy) - 22/23 October 2009

www.investinpolaris.it

OBJECTIVES

Produce technology by doing research in fields related to life, health, needs and environment of human beings

Partecipate in national and international collaborations with academic, public institutions and industrial partners

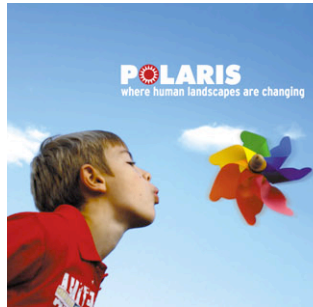

Investing & Partnering Forum on Biomedicine & ICTs
Polaris Science & Technology Park
Pula, Sardinia (Italy) - 22/23 October 2009

www.investinpolaris.it

THREAD

research > development > technology

WHICH RESEARCH?

mainly applied

some fundamental

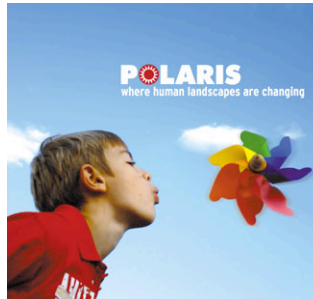

Investing & Partnering Forum on Biomedicine & ICTs
Polaris Science & Technology Park
Pula, Sardinia (Italy) - 22/23 October 2009

www.investinpolaris.it

research > development > technology

which developments ?

Enabling Technologies

Visual Computing

Computer & Network Platform

Genotyping & Sequencing Platform

Database Design & Integration

Applications and Vertical Integration:

Energy, Environment, Information Society,

Genomics, Medicine, Pharma, Biotech, Healthcare

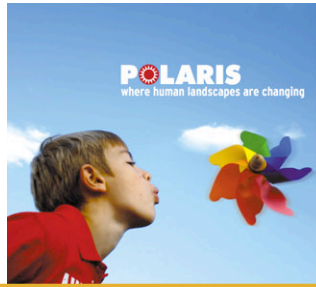

Investing & Partnering Forum on Biomedicine & ICTs
Polaris Science & Technology Park
Pula, Sardinia (Italy) - 22/23 October 2009

www.investinpolaris.it

research > development > **Technology**
modern innovation is ICT based

extraordinary developments in integrated circuits, fiber optics, internet & web, digital communications and in bio-medical & genomic technology

result in the production, transmission, storage, processing of huge amounts of digital data: **the Computer is the Heart and the Brain of any Solution**



Investing & Partnering Forum on Biomedicine & ICTs
 Polaris Science & Technology Park
 Pula, Sardinia (Italy) - 22/23 October 2009

www.investinpolaris.it

Matrix Model of CRS4 Structure

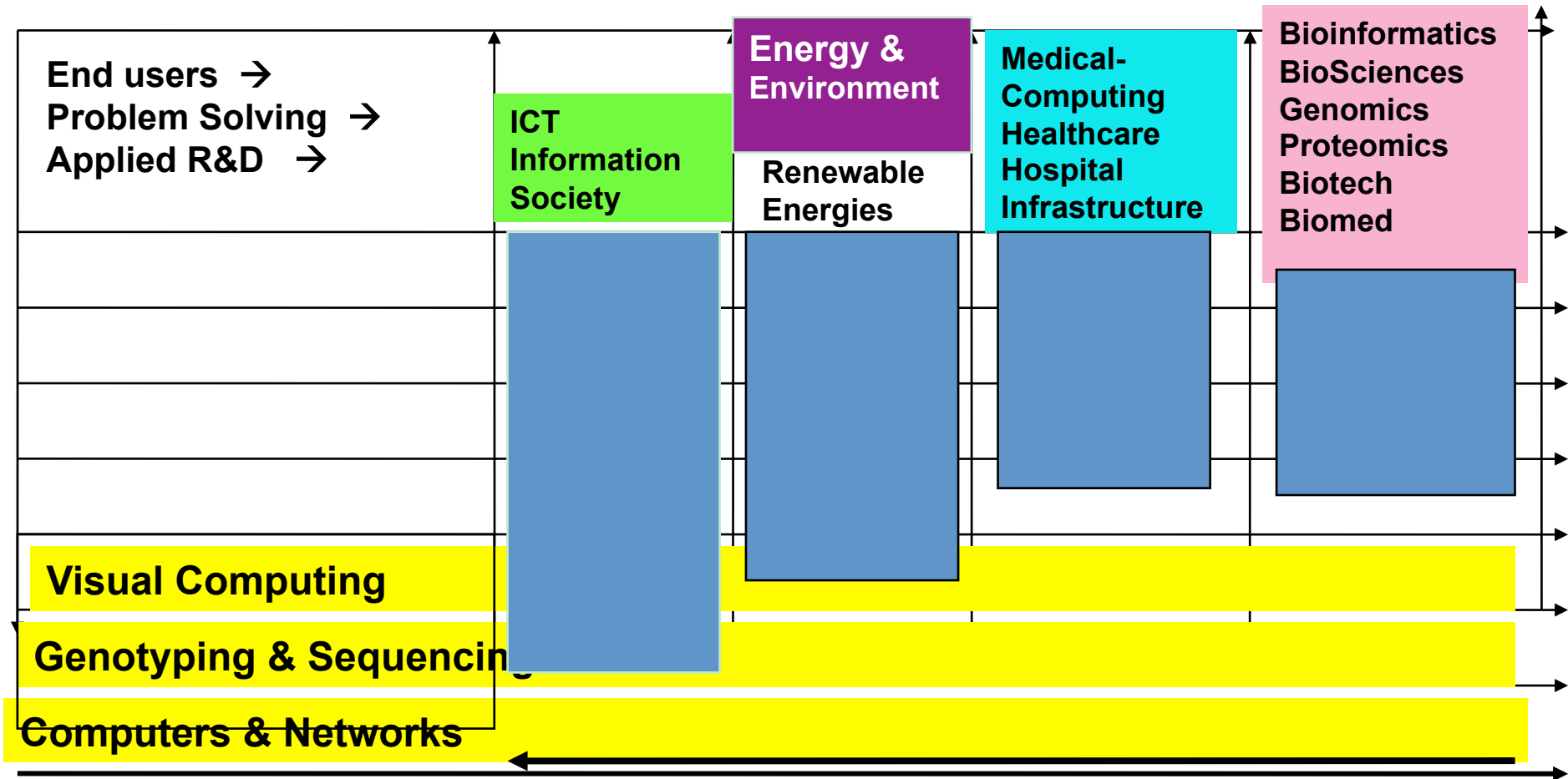

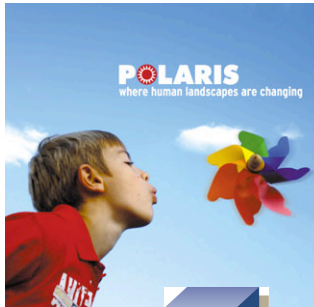

POLARIS
where human landscapes are changing

Investing & Partnering Forum on Biomedicine & ICTs
Polaris Science & Technology Park
Pula, Sardinia (Italy) - 22/23 October 2009

www.investinpolaris.it

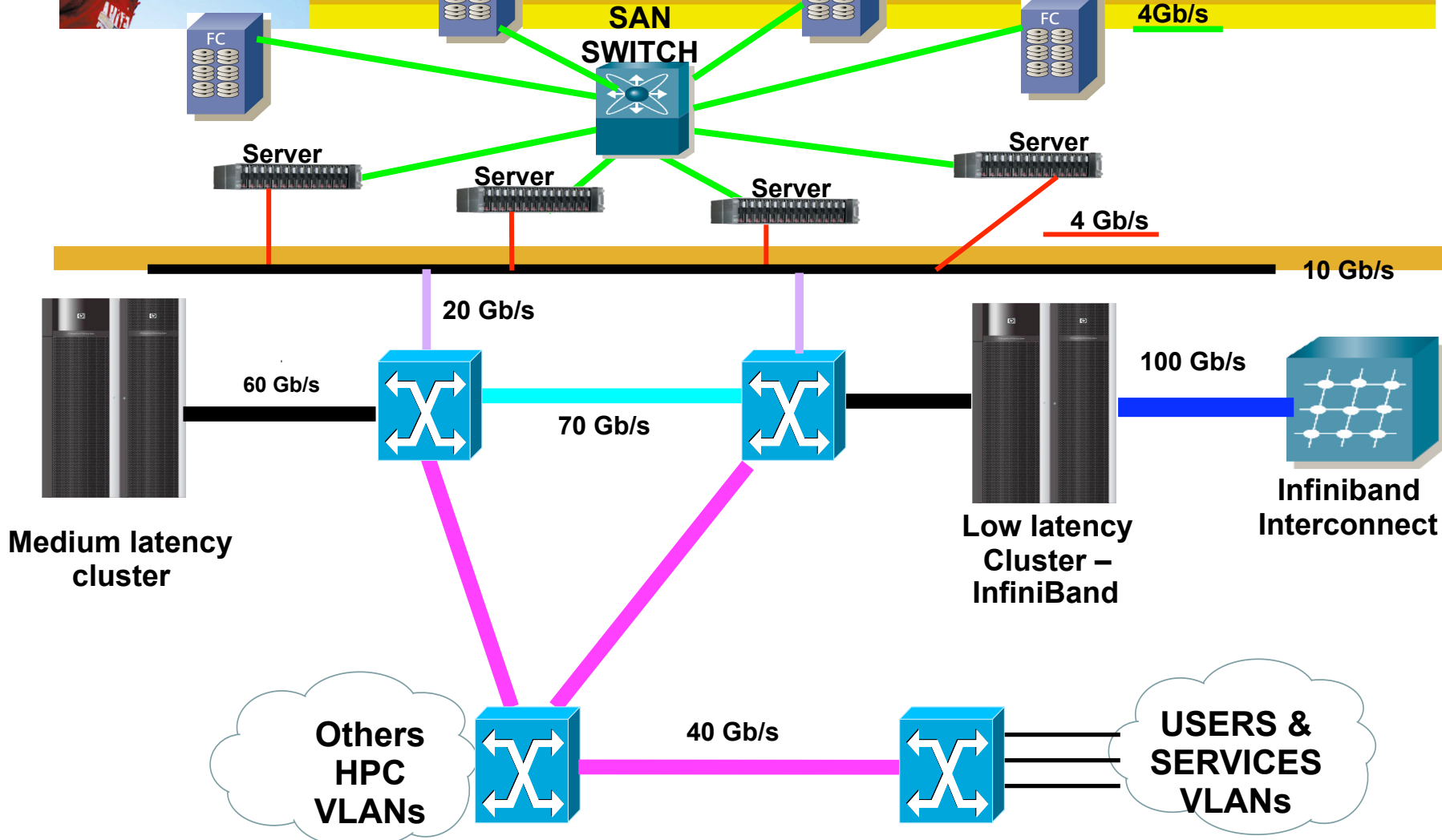

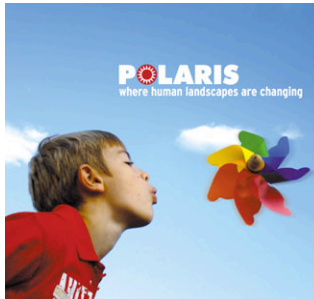

Investing & Partnering Forum on Biomedicine & ICTs
Polaris Science & Technology Park
 Pula, Sardinia (Italy) - 22/23 October 2009

www.investinpolaris.it

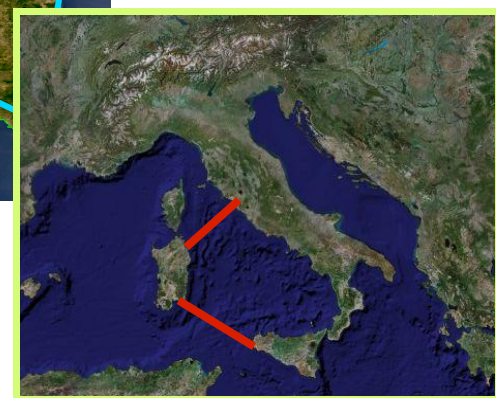
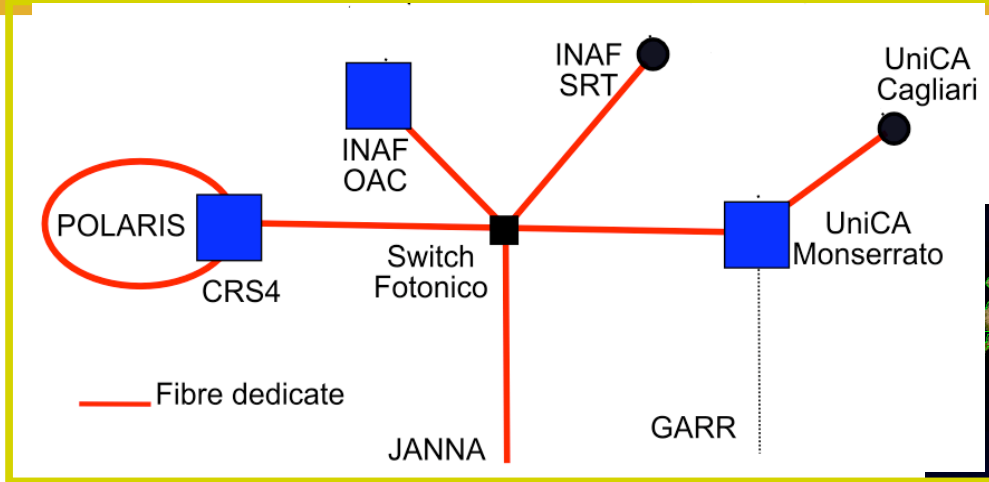

Janna dark fibers

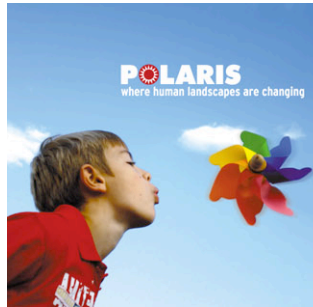

Investing & Partnering Forum on Biomedicine & ICTs
Polaris Science & Technology Park
Pula, Sardinia (Italy) - 22/23 October 2009

www.investinpolaris.it

HP CLUSTER & NETWORK CAPACITY

Intel Quadricore chips 2 billion tr.

35 Teraflops

disk storage: 1 Petabyte and growing

Top 500 in the World: <200th position

2009: 1 Gigabit/s WAN capacity

2010: 10 Gigabit/s

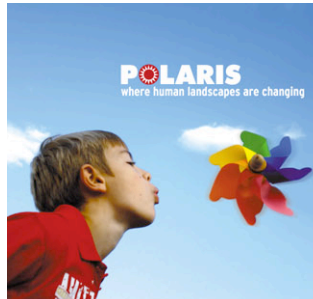

Investing & Partnering Forum on Biomedicine & ICTs
Polaris Science & Technology Park
Pula, Sardinia (Italy) - 22/23 October 2009

www.investinpolaris.it

What is so special about CRS4?

not-for-profit

multi-disciplinary R&D team of 200

based in Sardinia

building and running two world-class platforms

ICT/computing/networks and genotyping
/sequencing

technology creation & transfer

hi-tech services to Industry and Institutions

applications development & integration

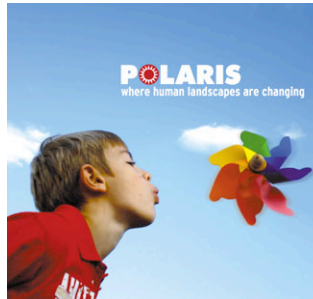

Investing & Partnering Forum on Biomedicine & ICTs
Polaris Science & Technology Park
Pula, Sardinia (Italy) - 22/23 October 2009

www.investinpolaris.it

*“If it were not for the great variability
among individuals,
Medicine might be a Science,
not an Art”*

*Sir William Osler, 1892
The Principles and Practice of Medicine*

This is still a Grand Challenge!
**At Polaris we are developing technology which
may help solving this problem**